

Orthopaedic Catalog

Prepared for: Internal Fixation-TC-100 Plating and Screws Systems

Prepared by: (Entire Catalog)

Contact Info:

Date Prepared: 10/16/2003 2:08:44 PM

Smith & Nephew, Inc.
1450 Brooks Road
Memphis, TN 38116 U.S.A

For Orders and other Inquiries: 1.800.238.7538
www.smithnephew.com/ortho

Copyright of Smith & Nephew, Inc.

SMITH & NEPHEW, INC.

PRODUCT CATALOG

Catalog Contents

Trauma Surgery	3
Internal Fixation	4
TC-100 Plating and Screws Systems/Instruments	4
TC-100 Plating and Screws Systems/K-Wires	9
TC-100 Plating and Screws Systems/Plates/Blade Plates	9
TC-100 Plating and Screws Systems/Plates/Cannulated Blade Plates	11
TC-100 Plating and Screws Systems/Plates/Large Fragment Plates	12
TC-100 Plating and Screws Systems/Plates/Mini Fragment Plates	14
TC-100 Plating and Screws Systems/Plates/Pelvic Fragment Plates	16
TC-100 Plating and Screws Systems/Plates/Small Fragment Plates	17
TC-100 Plating and Screws Systems/Screws/Cancellous Bone Screws	19
TC-100 Plating and Screws Systems/Screws/Cortical Bone Screws	20
TC-100 Plating and Screws Systems/Screws/Screw Accessories (Washers & Nuts)	23
TC-100 Plating and Screws Systems/Screws/Specialty Bone Screws	24
TC-100 Plating and Screws Systems/Sets/Blade Plate Sets	25
TC-100 Plating and Screws Systems/Sets/Large Fragment Sets/Screw Sets	25
TC-100 Plating and Screws Systems/Sets/Mini Fragment Sets/Cortical Screw Sets	27
TC-100 Plating and Screws Systems/Sets/Pelvic Fragment Sets/Implant Set	28
TC-100 Plating and Screws Systems/Sets/Small Fragment Sets	29
TC-100 Plating and Screws Systems/Trays/Blade Plate Trays	33
TC-100 Plating and Screws Systems/Trays/Large Fragment Trays	33
TC-100 Plating and Screws Systems/Trays/Mini Fragment Trays	34
TC-100 Plating and Screws Systems/Trays/Pelvic Fragment Trays	35
TC-100 Plating and Screws Systems/Trays/Small Fragment Trays	35

TABLE OF CONTENTS

Trauma Surgery

Trauma Surgery

Internal Fixation	4
TC-100 Plating and Screws Systems/Instruments	4
TC-100 Plating and Screws Systems/K-Wires	9
TC-100 Plating and Screws Systems/Plates/Blade Plates	9
TC-100 Plating and Screws Systems/Plates/Cannulated Blade Plates	11
TC-100 Plating and Screws Systems/Plates/Large Fragment Plates	12
TC-100 Plating and Screws Systems/Plates/Mini Fragment Plates	14
TC-100 Plating and Screws Systems/Plates/Pelvic Fragment Plates	16
TC-100 Plating and Screws Systems/Plates/Small Fragment Plates	17
TC-100 Plating and Screws Systems/Screws/Cancellous Bone Screws	19
TC-100 Plating and Screws Systems/Screws/Cortical Bone Screws	20
TC-100 Plating and Screws Systems/Screws/Screw Accessories (Washers & Nuts)	23
TC-100 Plating and Screws Systems/Screws/Specialty Bone Screws	24
TC-100 Plating and Screws Systems/Sets/Blade Plate Sets	25
TC-100 Plating and Screws Systems/Sets/Large Fragment Sets/Screw Sets	25
TC-100 Plating and Screws Systems/Sets/Mini Fragment Sets/Cortical Screw Sets	27
TC-100 Plating and Screws Systems/Sets/Pelvic Fragment Sets/Implant Set	28
TC-100 Plating and Screws Systems/Sets/Small Fragment Sets	29
TC-100 Plating and Screws Systems/Trays/Blade Plate Trays	33
TC-100 Plating and Screws Systems/Trays/Large Fragment Trays	33
TC-100 Plating and Screws Systems/Trays/Mini Fragment Trays	34
TC-100 Plating and Screws Systems/Trays/Pelvic Fragment Trays	35
TC-100 Plating and Screws Systems/Trays/Small Fragment Trays	35

Internal Fixation

TC-100 Plating and Screws Systems/Instruments

Asymmetric Pelvic Reduction Forceps

Cat. No.
7117-0213



Bending Templates (7117-1007 Shown Below)

Cat. No.	Desc
7117-0107	Template, 7 Holes, Large
7117-0109	Template, 9 Holes, Large
7117-0112	Template, 12 Holes, Large
7117-0177	Template, 3.5mm Reconstruction Plates, Straight
7117-0179	Template, 3.5mm Reconstruction Plates, Curved
7117-0181	Template, 4.5mm Reconstruction Plates, Straight
7117-1005	Template, 5 Holes, Small
7117-1007	Template, 7 Holes, Small
7117-1009	Template, 9 Holes, Small
7117-1012	Template, 12 Holes, Small



Blade Plate Instrumentation Set, 7117-5000 Set Contains the Following:

(Not shown)

Cat. No.	Desc	Qty
7117-5013	Triple Drill Guide	1
7117-5015	Router, Quick Coupling	1
7117-5100	Chisel Guide with Adjustable Angle	1
7117-5132	Seating Chisel, Adult, 320mm	1
7117-5126	Seating Chisel, Infant, 260mm	1
7117-5114	Seating Chisel, Adolescent and	1

Blade Plate Instrumentation Set, 7117-5000 Set Contains the Following:

Cat. No.	Desc	Qty
	Child	
7117-5200	Inserter/Extractor, Adult/Small Statured Adult	1
7117-5210	Inserter/Extractor, Adolescent and Child	1
7117-5300	Slotted Hammer	1
7117-5350	Impactor	1
7117-5225	Inserter for Bifurcated Infant Plate	1
7117-5400	Triangular Positioning Plate, Small, 90→/50→/40→	1
7117-5410	Triangular Positioning Plate, Small, 80→/70→/30→	1
7117-5420	Triangular Positioning Plate, Small, 100→/60→/20→	1
7117-5430	Triangular Positioning Plate, Small, 110→/60→/10→	1
7117-5450	Quadrangular Positioning Plate, 110→/90→/90→/90→	1
7117-5460	Condylar Plate Guide	1
7117-5545	Drill Guide, Hip 4.5mm	1
7117-5005	Blade Plate Instrumentation Tray	1

Blunt Pelvic Retractor

Cat. No.
7117-0191



Bone Hook, Large

Cat. No.
7117-0187



Countersinks

Cat. No.	Desc
7117-0009	Countersink for 1.5mm/2.0mm Screws
7117-0075	Countersink for 2.7mm/3.5mm/4.0mm Screws
7117-0115	Countersink for 4.5mm/6.5mm Screws



Trauma Surgery

Internal Fixation

Depth Gauges

(7117-0041 Shown Below)

Cat. No.	Desc
7117-0041	Gauge for 1.5mm/2.0mm Screws, 38mm
7117-0039	Gauge for 2.7mm Screws, 50mm
7117-0139	Gauge for 4.5mm/6.5mm Screws, 110mm
7117-0171	Gauge for Small and Large Screws, 120mm



Drill Bits, Non-Quick Coupling



Cat. No.	Diameter (mm)	Length (mm)	Effective Length (mm)
7117-6511	1.1	45	N/A
7117-6516	1.5	95	N/A
7117-6521	2.0	110	N/A
7117-6525	2.5 (Gold)	95	N/A
7117-6528	2.7	110	97
7117-6532	3.2	130	115
7117-6533	3.2	180	165
7117-6535	3.5	95	80
7117-5637	3.5	180	165
7117-6545	4.5	130	115
7117-6547	4.5	180	165

Sterile

Drill Bits, Quick Coupling



Cat. No.	Diameter (mm)	Length (mm)	Effective Length (mm)
7117-6011*	1.1	30	35
7117-0001	1.1	60	35
7117-6015*	1.5	85	60
7117-0003	1.5	85	60
7117-6016*	1.5	110	85
7117-6020*	2.0	100	75
7117-0005	2.0	100	75
7117-6021*	2.0	125	100
7117-6025*	2.5 (Gold)	110	85
7117-0071	2.5 (Gold)	110	85
7117-6026*	2.5 (Gold)	180	155
7117-3027*	2.7	100	75

Drill Bits, Quick Coupling

Cat. No.	Diameter (mm)	Length (mm)	Effective Length (mm)
7117-0007	2.7	100	75
7117-6028*	2.7	125	100
7117-0111	3.2	145	120
7117-6032*	3.2	145	120
7117-6033*	3.2	195	170
7117-6035*	3.5	110	85
7117-0073	3.5	110	85
7117-6037*	3.5	195	170
7117-0147	3.5	195	170
7117-0113	4.5	145	120
7117-6045*	4.5	145	120
7117-6047*	4.5	195	170
7117-0149	4.5	195	170

* Sterile

Drill Guides

Cat. No.	Description
7117-0081	Drill Guide, Neutral & Load, 2.7mm
7117-0086	Drill Guide, Neutral & Load, 3.5mm
7117-0129	Drill Guide, Neutral & Load, 4.5mm
7117-0087	Universal Drill Guide, 3.5mm
7117-0131	Universal Drill Guide, 4.5mm



Drill Sleeves



Cat. No.	Description
7117-0023	Double Drill Sleeve, 1.1mm/1.5mm
7117-0025	Double Drill Sleeve, 1.5mm/2.0mm
7117-0027	Double Drill Sleeve, 2.0mm/2.7mm
7117-0085	Double Drill Sleeve, 2.5mm/3.5mm
7117-0123	Double Drill Sleeve, 4.5mm/3.2mm
7117-0127	Double Drill Sleeve, 6.5mm/3.2mm
7117-0089	Insert Drill Sleeve, 2.5mm/3.5mm
7117-0125	Insert Drill Sleeve, 4.5mm/3.2mm
7117-0083	Parallel Drill Guide/Sleeve, 2.0mm

Farabeuf Forceps

Cat. No.	Size (mm)
7117-0195	190
7117-0197	250



Hohmann Retractor

Cat. No.	Width (mm)
7117-0055	6
7117-0057	8
7117-0095	15



Miscellaneous Instrumentation (Not shown)

Cat. No.	Desc
7117-0145	Articulated Tension Device with Gauge
7117-0141	Combination Wrench
7117-0045	Screw Forceps
7117-0002	Screw Forceps, Mini
7117-0143	Socket Wrench with Universal Joint

Periosteal Elevator (7117-0098 Shown Below)

Cat. No.	Width (mm)	Desc
7117-0059	3	Straight Edge
7117-0097	6	Curved Edge
7117-0098	6	Straight Edge



Plate Bending Instruments (7117-0101 Shown Below)



Cat. No.	Desc
7117-0101	Bending Iron for 2.7mm and 3.5mm Plates, Left
7117-0103	Bending Iron for 2.7mm and 3.5mm Plates, Right
7117-0173	Bending Iron for 3.5mm and 4.5mm Twisting Reconstruction Plates
7117-0068	Bending Iron for Mini Plates

Plate Bending Instruments (7117-0101 Shown Below)

Cat. No.	Desc
7117-0099	Bending Iron, 1.25mm - 2.0mm K-Wire
7117-0176	Large Bending Press
7117-0174	Bending Iron for 4.5mm Plate (For Use with Bending Press)
7117-0061	Pliers for 1.5mm and 2.0mm Plates
7117-0076	Pliers for 2.7mm and 3.5mm Plates
7117-0175	Pliers for 3.5mm and 4.5mm Reconstruction Plates

Plate Cutting Forceps

Cat. No.
7117-0047



Plate/Bone Holding Forceps

Cat. No.
7117-0056



Plate/Bone Holding Forceps with Foot

Cat. No.
7117-0054



Reduction Forceps for Use with Screws

Cat. No.
7117-0211



Reduction Forceps with Points, 130mm, Ratchet

Cat. No.
7117-0052

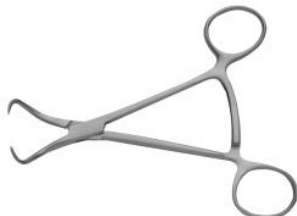

Reduction Forceps with Points, Broad

Cat. No.
7117-0051



Reduction Forceps with Points, Narrow

Cat. No.
7117-0049



Reduction Forceps with Serrated Jaws

Cat. No.
7117-0093



Reduction Forceps with Speed Lock

Cat. No.	Size (mm)
7117-0217	170
7117-0050	240



Reduction Forceps, 205mm

Cat. No.
7117-0044



Reduction Forceps, 3-Pointed Ball Tips

Cat. No.	Size (mm)
7117-0209	400



Reduction Forceps, Angled Point Ball Tips

Cat. No.	Size (mm)
7117-0205	250



Reduction Forceps, Pointed Ball Tips

Cat. No.	Size (mm)
7117-0199	200
7117-0203	240
7117-0207	400



Screwdrivers and Accessories



Cat. No.	Desc
7117-0013	Quick Coupling Handle, Mini
7117-0072	Quick Connect Adaptor for Jacobs
7117-0117	Quick Coupling T-Handle, Small
7117-0015	Quick Coupling Handle, Small
7117-0037	Cruciform Screwdriver Shaft, Mini
7117-0036	Hex Screwdriver Shaft, Mini
7117-1035	Hex Screwdriver Shaft, Small
7117-0137	Hex Screwdriver Shaft, Large
7117-0163	Hex Screwdriver Shaft, Large, Long
7117-0033	Hex Screwdriver Shaft, Small
7117-0169	Hex Screwdriver Shaft, Small, Long
7117-0133	Hex Screwdriver Shaft, Large
7117-0161	Hex Screwdriver, Large, Long
7117-0029	Hex Screwdriver, Small
7117-0165	Hex Screwdriver, Small, Long
7117-0135	Holding Sleeve for Hex Screwdriver, Large
7117-0167	Holding Sleeve for Hex Screwdriver, Small
7117-0034	Holding Sleeve for Mini Shaft, Cruciform and Hex 2.0mm Screws
7117-0035	Self-Holding Sleeve for 1.5mm Mini Screws
7117-0031	Split Holding Sleeve for Hex Driver,

Screwdrivers and Accessories

Cat. No.	Desc.
	Small

Self-Centering Forceps with Speed Lock

Cat. No.	Size (mm)
7117-0046	240
7117-0215	260
7117-0048	280



Self-Centering Forceps, 150mm

Cat. No.
7117-0092



Sharp Hook

Cat. No.
7117-0043



Spiked Disk

Cat. No.
7117-0193



Stagbeetle Forceps, 120 mm

Cat. No.
7117-0053



Straight Ball Spike

Cat. No.
7117-0189



Taps



Cat. No.	Description
7117-0157	Calibrated Tap, 3.5mm
7117-0159	Calibrated Tap, 4.5mm
7117-0079	Tap for Cancellous Bone Screws, 4.0mm
7117-0077	Tap for Cortex Bone Screws, 3.5mm, Gold
7117-0017	Tap, 1.5mm
7117-0019	Tap, 2.0mm
7117-0021	Tap, 2.7mm
7117-0119	Tap, 4.5mm
7117-0121	Tap, 6.5mm

Three-Fluted Drill Bits, Quick Coupling



Cat. No.	Diameter(mm)	Length (mm)	Effective Length (mm)
7117-6125*	2.5	230	205
7117-0153	2.5	230	205
7117-6132*	3.2	230	205
7117-0155	3.2	230	205
7117-0151	4.5	196	170
7117-6145*	4.5	196	170

* Sterile

Universal Chuck with T-Handle

Cat. No.
7117-0183



Trauma Surgery

Internal Fixation

Verbrugge Self-Centering Forceps, Size 0

Cat. No.
7117-0091



Volkman Bone Hook, Medium

Cat. No.
7117-0185



Wire Bending Pliers, 140mm

Cat. No.
7117-0063



Wire Cutter, 175mm

Cat. No.
7117-0065



Wire Cutter, 220mm

Cat. No.
7117-0078



TC-100 Plating and Screws Systems/K-Wires

K-Wires

Sterile, 6 per package

(Not shown)

Cat. No.	Description	Diameter (mm)	Length (mm)
7116-3006	Cerclage Wire	0.6	175
7116-3008	Cerclage Wire	0.8	200
7116-1066	K-Wire, Trocar Point	0.6	70

K-Wires

Sterile, 6 per package

Cat. No.	Description	Diameter (mm)	Length (mm)
7116-1008	K-Wire, Trocar Point	0.8	70
7116-1010	K-Wire, Trocar Point	1.0	150
7116-1012	K-Wire, Trocar Point	1.25	150
7116-1016	k-Wire, Trocar Point	1.6	150
7116-1020	K-Wire, Trocar Point	2.0	150

TC-100 Plating and Screws Systems/Plates/Blade Plates

115° Bifurcated Infant Blade Plate

Cat. No.	Blade Length (mm)	Displacement (mm)
7122-5610	30	5
7122-5611	35	5



130° Adult Angled Blade Plate

Cat. No.	Blade Length (mm)	Shaft Len (mm)
7122-5500	50	60
7122-5511	50	104
7122-5501	60	60
7122-5512	60	104
7122-5502	70	60
7122-5513	70	104
7122-5516	70	152
7122-5519	70	200
7122-5503	75	60
7122-5504	80	60
7122-5514	80	104
7122-5517	80	152
7122-5520	80	200



130° Adult Angled Blade Plate

Cat. No.	Blade Length (mm)	Shaft Length (mm)	Holes
7122-5505	85	60	4
7122-5506	90	60	4
7122-5515	90	104	6
7122-5518	90	152	9
7122-5521	90	200	12
7122-5507	95	60	4
7122-5508	100	60	4
7122-5509	105	60	4
7122-5510	110	60	4

90° Infant Osteotomy, 3 Holes

Cat. No.	Blade Length (mm)	Displacement (mm)
7122-5600	25	7
7122-5601	25	12
7122-5602	32	7
7122-5603	32	12



130° Angled Blade Plate, Small Stature

Cat. No.	Blade Length (mm)	Shaft Length (mm)	Holes
7122-5530	50	60	4
7122-5534	50	104	6
7122-5538	50	152	9
7122-5531	60	60	4
7122-5535	60	104	6
7122-5539	60	152	9
7122-5532	70	60	4
7122-5536	70	104	6
7122-5540	70	152	9
7122-5533	80	60	4
7122-5537	80	104	6
7122-5541	80	152	9



95° Adult Condylar Plate

Cat. No.	Blade Length (mm)	Shaft Length (mm)	Holes
7122-5400	50	92	4
7122-5404	50	124	6
7122-5408	50	156	9
7122-5412	50	204	12
7122-5416	50	235	15
7122-5401	60	92	4
7122-5405	60	124	6
7122-5409	60	156	9
7122-5413	60	204	12
7122-5417	60	235	15
7122-5420	60	267	18
7122-5423	60	299	21
7122-5402	70	92	5
7122-5406	70	124	7
7122-5410	70	156	9
7122-5414	70	204	12
7122-5418	70	235	14
7122-5421	70	267	16
7122-5424	70	299	18
7122-5403	80	92	5
7122-5407	80	124	7
7122-5411	80	156	9
7122-5415	80	204	12
7122-5419	80	235	14
7122-5422	80	267	16
7122-5425	80	299	18



90° Adolescent Osteotomy, 3 Holes

Cat. No.	Blade Length (mm)	Displacement (mm)
7122-5640	40	10
7122-5641	40	15
7122-5642	50	10
7122-5643	50	15
7122-5644	60	15



Trauma Surgery

Internal Fixation

95° Condylar Plate, Small Stature

Cat. No.	Blade Length (mm)	Shaft Len (mm)	
7122-5430	40	92	
7122-5434	40	124	
7122-5438	40	156	
7122-5431	50	92	
7122-5435	50	124	
7122-5439	50	156	
7122-5432	60	92	
7122-5436	60	124	
7122-5440	60	156	9
7122-5433	70	92	5
7122-5437	70	124	7
7122-5441	70	156	9



Adult Osteotomy, 4 Holes

Cat. No.	Angle (degrees)	Blade Length (mm)	Displacement
7122-5336	90	60	20
7122-5337	90	70	20
7122-5338	90	75	20
7122-5339	100	50	10
7122-5340	100	60	10
7122-5341	110	65	N/A
7122-5342	110	75	N/A
7122-5343	110	85	N/A
7122-5344	120	65	N/A
7122-5345	120	75	N/A
7122-5346	120	85	N/A
7122-5347	130	65	N/A
7122-5348	130	70	N/A
7122-5349	130	75	N/A
7122-5350	130	80	N/A
7122-5351	130	85	N/A
7122-5352	130	90	N/A
7122-5353	130	95	N/A
7122-5354	130	100	N/A
7122-5355	130	105	N/A
7122-5356	130	110	N/A

Additional Blade Plate Instrumentation (Not shown)

Cat. No.	Desc
7117-5017	Router, Jacob's Chuck
7117-5128	Seating Chisel for Adult, 284mm
7117-5325	Hamer, 500g
7117-5500	Chisel Handle
7117-5505	Chisel Blade, 5mm
7117-5510	Chisel Blade, 10mm
7117-5516	Chisel Blade, 16mm
7117-5525	Chisel Blade, 25mm

Child Osteotomy, 3 Holes

Cat. No.	Angle (degrees)	Blade Len (mm)
7122-5620	80	35
7122-5621	80	45
7122-5622	90	35
7122-5623	90	45
7122-5624	100	35
7122-5625	100	45



Adult Osteotomy, 4 Holes

Cat. No.	Angle (degrees)	Blade Len (mm)	
7122-5320	90	40	
7122-5321	90	50	
7122-5322	90	55	
7122-5323	90	60	
7122-5324	90	65	
7122-5325	90	70	
7122-5326	90	80	
7122-5327	90	40	
7122-5328	90	50	15
7122-5329	90	55	15
7122-5330	90	60	15
7122-5331	90	65	15
7122-5332	90	70	15
7122-5333	90	75	15
7122-5334	90	80	15
7122-5335	90	50	20



TC-100 Plating and Screws Systems/Plates/Cannulated Blade Plates

Cannulated Osteotomy Blade Plates

Stainless Steel (ASTM F 138)



Cat. No.	Holes	Desc	Blade Length (mm)
90-5479	3	Infant	20
90-5478	3	Infant	25
90-5477	3	Infant	30
90-5482	3	Children	30
90-5365	3	Children	35
90-5481	3	Children	40
90-5480	3	Children	45
90-5486	3	Adolescent	35
90-5485	3	Adolescent	40
90-5484	3	Adolescent	45
90-5483	3	Adolescent	50
7192-2580	4	Children	30
7192-2583	4	Children	35
7192-2581	4	Children	40
7192-2582	4	Children	45
7192-2584	4	Adolescent	35
7192-2585	4	Adolescent	40
7192-2586	4	Adolescent	45
7192-2587	4	Adolescent	50

TC-100 Plating and Screws

Systems/Plates/Large Fragment Plates

4.5mm Broad Compression Plates

Thickness: 5mm Width: 16mm Hole Spacing: 16mm & 25mm



Cat. No.	Length (mm)	Holes
7114-1206	103	6
7114-1207	119	7
7114-1208	135	8
7114-1209	151	9
7114-1210	167	10

4.5mm Broad Compression Plates

Thickness: 5mm Width: 16mm Hole Spacing: 16mm & 25mm

Cat. No.	Length (mm)	Holes
7114-1212	199	12
7114-1214	231	14
7114-1216	263	16
7114-1218	295	18
7114-1220	326	20
7114-1222	358	22
7114-1224	390	24
7114-1226	423	26

4.5mm Narrow Compression Plates

Thickness: 4mm Width: 12mm Hole Spacing: 16mm & 25mm



Cat. No.	Length (mm)	Holes
7114-1402	39	2
7114-1403	55	3
7114-1404	71	4
7114-1405	87	5
7114-1406	103	6
7114-1407	119	7
7114-1408	135	8
7114-1409	151	9
7114-1410	167	10
7114-1411	183	11
7114-1412	199	12
7114-1413	215	13
7114-1414	231	14
7114-1415	247	15
7114-1416	263	16
7114-1418	295	18
7114-1420	326	20
7114-1422	358	22
7114-1424	390	24

Cobra Head Plates

Thickness (Shaft): 5mm Width (Shaft): 16mm



Cat. No.	Length (mm)	Holes in Shaft
7114-1808	170	8
7114-1809	188	9
7114-1810	202	10

Trauma Surgery

Internal Fixation

Cobra Head Plates

Thickness (Shaft): 5mm Width (Shaft): 16mm

Cat. No.	Length (mm)	Holes in Shaft
7114-1811	218	11

Condylar Buttress Plates

Thickness (Shaft): 4.8mm Width (Shaft): 16mm Hole Spacing: 16mm



Cat. No.	Description	Length (mm)	Holes in Shaft
7114-2007	Left	158	7
7114-2107	Right	158	7
7114-2009	Left	190	9
7114-2109	Right	190	9
7114-2011	Left	221	11
7114-2111	Right	221	11
7114-2013	Left	253	13
7114-2113	Right	253	13
7114-2015	Left	285	15
7114-2115	Right	285	15

Hook Plate

Thickness (Shaft): 5.8mm Width (Shaft): 16.2mm



Cat. No.	Length (mm)	Holes in Shaft
7114-1704	123	4

Large T-Plates

Thickness: 2mm Width (Shaft): 17mm



Cat. No.	Length (mm)	Holes in Shaft
7114-1603	68	3
7114-1604	84	4
7114-1605	100	5
7114-1606	116	6
7114-1608	148	8

Lateral Tibial Head Buttress Plates

Thickness (Shaft): 4mm Width (Shaft): 14mm Hole Spacing: 16mm



Cat. No.	Description	Length (mm)	Holes in Shaft
7114-1003	Right	86.5	3
7114-1103	Left	86.5	3
7114-1005	Right	188	5
7114-1105	Left	188	5
7114-1007	Right	149	7
7114-1107	Left	149	7
7114-1009	Right	181	9
7114-1109	Left	181	9
7114-1011	Right	214	11
7114-1111	Left	214	11
7114-1013	Right	246	13
7114-1113	Left	246	13

L-Buttress Plates

Thickness: 2mm Width (Shaft): 16mm



Cat. No.	Description	Length (mm)	Holes in Shaft
7114-0804	Angled Left for Right Tibia	86	4
7114-0904	Angled Right for Left Tibia	86	4

Semi-Tubular Plates

Thickness: 1mm Width: 11.7mm Hole Spacing: 16mm & 26mm



Cat. No.	Length (mm)	Holes
7114-1302	39	2
7114-1303	55	3
7114-1304	71	4
7114-1305	87	5
7114-1306	103	6
7114-1307	119	7
7114-1308	135	8
7114-1309	151	9
7114-1310	167	10
7114-1311	183	11
7114-1312	199	12

Spoon Plates

Thickness (Shaft): 2mm Width (Head): 34mm



Cat. No.	Length (mm)	Holes in Shaft
7114-1505	100	5
7114-1506	120	6

T-Buttress Plates

Thickness: 2mm Width (Shaft): 17mm



Cat. No.	Length (mm)	Holes in Shaft
7114-0704	80	4
7114-0705	96	5
7114-0706	112	6

TC-100 Plating and Screws Systems/Plates/Mini Fragment Plates

1.5mm Condylar Plates

Thickness: 0.9mm Width: 3.5mm Length: 36mm



Cat. No.	Holes	Description
7114-5026	7	Left
7114-5028	7	Right

1.5mm H-Plate

Thickness: 0.9mm



Cat. No.	Holes
7114-5030	4

1.5mm Straight Plate

Thickness: 0.9mm Width: 3.8mm Hole Spacing: 5mm



Cat. No.	Length (mm)	Holes
7114-5020	100	20

1.5mm T-Plates

Thickness: 0.9mm Width: 3.8mm Length: 49mm



Cat. No.	Holes in Head	Holes in Shaft
7144-5022	3	9
7114-5024	4	9

2.0mm Condylar Plates

Thickness: 1.2mm Width: 5mm Length: 39mm



Cat. No.	Holes	Description
7114-6040	7	Left
7114-6042	7	Right

Trauma Surgery

Internal Fixation

2.0mm H-Plate

Thickness: 0.9mm



Cat. No.	Holes
7114-6048	4

2.0mm T-Plate, 2 Hole

Thickness: 0.9mm Width: 5mm Hole Spacing: 6mm



Cat. No.	Holes in Head	Holes in Shaft
7114-6034	2	2

2.0mm L-Plates

Thickness: 0.9mm Width: 5mm Hole Spacing: 6mm



Cat. No.	Holes in Shaft	Description
7114-6036	2	Oblique Right
7114-6038	2	Oblique Left
7114-6044	2	Right
7114-6046	2	Left

2.0mm T-Plates, 9 Hole

Thickness: 1.2mm Width: 5mm Hole Spacing: 5mm



Cat. No.	Holes in Head	Holes in Shaft
7114-6030	3	9
7114-6032	4	9

2.0mm Straight Plates

Thickness: 1.2mm Width: 5mm Hole Spacing: 6mm For 20 Hole Plate

Thickness: 1.2mm Width: 5mm Hole Spacing: 5mm



Cat. No.	Length (mm)	Holes
7114-6020	17	3
7114-6022	23	4
7114-6024	29	5
7114-6026	35	6
7114-3028	100	20

2.7mm Condylar Plates

Thickness: 1.4mm Width: 7mm Length: 57mm



Cat. No.	Holes	Description
7114-7008	7	Left
7114-7010	7	Right

2.7mm L-Plates

Thickness: 1.2mm Width: 7mm Hole Spacing: 8mm



Cat. No.	Length (mm)	Description
7114-7003	35	Left
7114-7001	35	Right
7114-7002	35	Oblique Left
7114-7004	35	Oblique Right

2.7mm Small Compression Plates

Sterile Width: 8mm



Cat. No.	Length (mm)	Holes
7114-1900	20	2
7114-1902	26	2
7114-1904	36	4
7114-1905	44	5
7114-1906	52	6
7114-1907	60	7
7114-1908	68	8
7114-1909	76	9
7114-1910	84	10
7114-1912	100	12

2.7mm T-Plates

Thickness: 1.2mm Width: 7mm Hole Spacing: 8mm



Cat. No.	Length (mm)
7114-7006	32

Multifragment Plate

Thickness: 1.2mm



Cat. No.	Holes
7114-7012	7

Quarter - Tubular Plates

Thickness: 1mm Width: 7mm Hole Spacing: 8mm



Cat. No.	Length (mm)	Holes
7114-8003	23	3

Quarter - Tubular Plates

Thickness: 1mm Width: 7mm Hole Spacing: 8mm

Cat. No.	Length (mm)	Holes
7114-8004	31	4
7114-8005	39	5
7114-8006	47	6
7114-8007	55	7
7114-8008	63	8

TC-100 Plating and Screws

Systems/Plates/Pelvic Fragment Plates

3.5mm Curved Reconstruction Plates

Thickness: 3.6mm Width: 10mm Hole Spacing: 12mm



Cat. No.	Length (mm)	Holes
7114-0606	70	6
7114-0608	94	8
7114-0610	118	10
7114-0612	142	12
7114-0614	166	14
7114-0616	190	16
7114-0618	214	18

3.5mm Reconstruction Plates

Thickness: 2.8mm Width: 10mm Hole Spacing: 12mm



Cat. No.	Length (mm)	Holes
7114-0104	46	4
7114-0105	58	5
7114-0106	70	6
7114-0107	82	7
7114-0108	94	8
7114-0109	106	9
7114-0110	118	10
7114-0111	130	11

Trauma Surgery

Internal Fixation

3.5mm Reconstruction Plates

Thickness: 2.8mm Width: 10mm Hole Spacing: 12mm

Cat. No.	Length (mm)	Holes
7114-0112	142	12
7114-0113	154	13
7114-0114	166	14
7114-0115	178	15
7114-0116	190	16
7114-0118	214	18
7114-0120	238	20
7114-0122	263	22

4.5mm Reconstruction Plates

Thickness: 2.8mm Width: 12mm Hole Spacing: 16mm

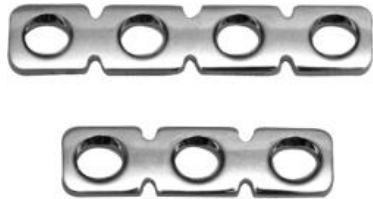

Cat. No.	Length (mm)	Holes
7114-0003	45	3
7114-0004	61	4
7114-0005	77	5
7114-0006	93	6
7114-0007	109	7
7114-0008	125	8
7114-0009	141	9
7114-0010	157	10
7114-0011	173	11
7114-0012	189	12
7114-0013	205	13
7114-0014	221	14
7114-0015	237	15
7114-0016	253	16

TC-100 Plating and Screws

Systems/Plates/Small Fragment Plates

3.5mm Reconstruction Plates

Thickness: 2.8mm Width: 10mm Hole Spacing: 12mm



Cat. No.	Length (mm)	Holes
7114-0104	46	4
7114-0105	58	5
7114-0106	70	6
7114-0107	82	7
7114-0108	94	8
7114-0109	106	9
7114-0110	118	10
7114-0111	130	11
7114-0112	142	12
7114-0113	154	13
7114-0114	166	14
7114-0115	178	15
7114-0116	190	16
7114-0118	214	18
7114-0120	238	20
7114-0122	263	22

3.5mm Small Compression Plates

Thickness: 3.4mm Width: 10mm Hole Spacing: 12mm & 16mm



Cat. No.	Length (mm)	Holes
7114-0202	25	2
7114-0203	37	3
7114-0204	49	4
7114-0205	61	5
7114-0206	73	6
7114-0207	85	7
7114-0208	97	8
7114-0209	109	9
7114-0210	121	10
7114-0212	145	12
7114-0214	169	14
7114-0216	194	16
7114-0218	217	18
7114-0220	242	20
7114-0222	265	22

Calcaneal Plate with Templates, 60mm

Sterile

Cat. No.
7114-4010



Calcaneal plate with Templates, 70mm

Sterile

Cat. No.
7114-4011



Calcaneal Plate with Templates, 9 Holes

Sterile

Cat. No.
7114-4012



Cloverleaf Plates

Thickness (Shaft): 2mm Thickness (Head): 1.2mm Width (Shaft): 15.8mm



Cat. No.	Length (mm)	Holes in Shaft
7114-0603	88	3
7114-0604	104	4
7114-0625*	120	5
7114-0626*	136	6
7114-0327*	152	7
7114-0628*	168	8
7114-0629*	184	9

* Sterile

One-Third Tubular Plates with Collar

Thickness: 1.1mm Width: 9mm Hole Spacing: 12mm & 16mm



Cat. No.	Length (mm)	Holes
7114-0302	25	2
7114-0303	37	3
7114-0304	49	4
7114-0305	61	5
7114-0306	73	6
7114-0307	85	7
7114-0908	97	8
7114-0309	109	9
7114-0310	121	10
7114-0312	145	12

Small T-Plates, Oblique

Thickness (Shaft): 1.5mm Width (Shaft): 10mm



Cat. No.	Length (mm)	Holes in Head	Holes in Shaft
7114-0503	53	3	3
7114-0504	63	3	4
7114-0505	73	3	5

Small T-Plates, Right Angle

Thickness (Shaft): 1.2mm Width (Shaft): 10mm for 3 Hole Head 11mm for 4 Hole Head



Cat. No.	Length (mm)	Holes in Head	Holes in Shaft
7114-0403	50	3	3
7114-0404	56	4	4
7114-0405	67	3	5
7114-0406	78	4	6

TC-100 Plating and Screws Systems/Screws/Cancellous Bone Screws

4.0mm Fully Threaded Cancellous Screws

Thread Pitch: 1.75mm Core Diameter: 1.9mm Shaft Diameter: 2.4mm
Head Diameter: 6.0mm (7122-3030 Shown)

Cat. No.	Length (mm)
----------	-------------

7122-3010	10
7122-3012	12
7122-3014	14
7122-3016	16
7122-3018	18
7122-3020	20
7122-3022	22
7122-3024	24
7122-3026	26
7122-3028	28
7122-3030	30
7122-3032	32
7122-3035	35
7122-3036	36
7122-3040	40
7122-3045	45
7122-3050	50
7122-3055	55
7122-3060	60
7122-3065	65
7122-3070	70
7122-3075	75
7122-3080	80
7122-3085	85
7122-3090	90
7122-3095	95
7122-3100	100



4.0mm Partially Threaded Cancellous Screws

Thread Pitch: 1.75mm Core Diameter: 1.9mm Shaft Diameter: 2.4mm
Head Diameter: 6.0mm (7122-3230 Shown)

Cat. No.	Length (mm)
----------	-------------

7122-3210	10
7122-3212	12
7122-3214	14
7122-3216	16
7122-3218	18
7122-3220	20
7122-3222	22



4.0mm Partially Threaded Cancellous Screws

Thread Pitch: 1.75mm Core Diameter: 1.9mm Shaft Diameter: 2.4mm
Head Diameter: 6.0mm (7122-3230 Shown)

Cat. No.	Length (mm)
----------	-------------

7122-3224	24
7122-3226	26
7122-3228	28
7122-3230	30
7122-3235	35
7122-3240	40
7122-3245	45
7122-3250	50
7122-3255	55
7122-3260	60
7122-3265	65
7122-3270	70
7122-3275	75
7122-3280	80
7122-3285	85
7122-3290	90
7122-3295	95
7122-3300	100

6.5mm Cancellous Screws, 16mm Thread Length

Thread Pitch: 2.75mm Core Diameter: 3.0mm Shaft Diameter: 4.5mm
Head Diameter: 8.0mm (7122-6115 Shown)

Cat. No.	Length (mm)
----------	-------------

7122-6030	30
7122-6035	35
7122-6040	40
7122-6045	45
7122-6050	50
7122-6055	55
7122-6060	60
7122-6065	65
7122-6070	70
7122-6075	75
7122-6080	80
7122-6085	85
7122-6090	90
7122-6095	95
7122-6100	100
7122-6105	105
7122-6110	110
7122-6115	115
7122-6120	120
7122-6125	125
7122-6130	130



6.5mm Cancellous Screws, 16mm Thread Length

Thread Pitch: 2.75mm Core Diameter: 3.0mm Shaft Diameter: 4.5mm
Head Diameter: 8.0mm (7122-6115 Shown)

Cat. No.	Length (mm)
7122-6135	135
7122-6140	140
7122-6145	145
7122-6150	150

6.5mm Cancellous Screws, 32mm Thread Length

Thread Pitch: 2.75mm Core Diameter: 3.0mm Shaft Diameter: 4.5mm
Head Diameter: 8.0mm (7122-8115 Shown)



Cat. No.	Length (mm)
7122-8045	45
7122-8050	50
7122-8055	55
7122-8060	60
7122-8065	65
7122-8070	70
7122-8075	75
7122-8080	80
7122-8085	85
7122-8090	90
7122-8095	95
7122-8100	100
7122-8105	105
7122-8110	110
7122-8115	115
7122-8120	120
7122-8125	125
7122-8130	130
7122-8135	135
7122-8140	140
7122-8145	145
7122-8150	150

6.5mm Fully Threaded Cancellous Screws

Thread Pitch: 2.75mm Core Diameter: 3.0mm Shaft Diameter: 4.5mm
Head Diameter: 8.0mm (7122-9060 Shown)



Cat. No.	Length (mm)
7122-9025	25
7122-9030	30
7122-9035	35
7122-9040	40
7122-9045	45

6.5mm Fully Threaded Cancellous Screws

Thread Pitch: 2.75mm Core Diameter: 3.0mm Shaft Diameter: 4.5mm
Head Diameter: 8.0mm (7122-9060 Shown)

Cat. No.	Length (mm)
7122-9050	50
7122-9055	55
7122-9060	60
7122-9065	65
7122-9070	70
7122-9075	75
7122-9080	80
7122-9085	85
7122-9090	90
7122-9095	95
7122-9100	100
7122-9105	105
7122-9110	110
7122-9115	115
7122-9120	120
7122-9125	125
7122-9130	130
7122-9135	135
7122-9140	140
7122-9145	145
7122-9150	150

TC-100 Plating and Screws Systems/Screws/Cortical Bone Screws

1.5mm Cortex Screws, Cruciate Head

Thread Pitch: 0.5mm Core Diameter: 1.0mm Head Diameter: 3.0mm
(7116-1612 Shown)



Cat. No.	Self-Tapping Cat. No.	Length (mm)
7116-1606	7114-9006	6
7116-1607	7114-9007	7
7116-1608	7114-9008	8
7116-1609	7114-9009	9
7116-1610	7114-9010	10
7116-1611	7114-9011	11
7116-1612	7114-9012	12
7116-1614	7114-9014	14
7116-1616	7114-9016	16
7116-1618	7114-9018	18

Trauma Surgery

Internal Fixation

1.5mm Cortex Screws, Cruciate Head

Thread Pitch: 0.5mm Core Diameter: 1.0mm Head Diameter: 3.0mm
(7116-1612 Shown)

Cat. No.	Self-Tapping Cat. No.	Length (mm)
7116-1620	7114-9020	20
N/A	7114-9022	22
N/A	7114-9024	24

1.5mm Cortex Screws, Hexagonal Head

Thread Pitch: 0.5mm Core Diameter: 1.0mm Head Diameter: 3.0mm
(7116-1512 Shown)



Cat. No.	Self-Tapping Cat. No.	Length (mm)
7116-1506	7114-9106	6
7116-1507	7114-9107	7
7116-1508	7114-9108	8
7116-1509	7114-9109	9
7116-1510	7114-9110	10
7116-1511	7114-9111	11
7116-1512	7114-9112	12
7116-1514	7114-9114	14
7116-1516	7114-9116	16
7116-1518	7114-9118	18
7116-1520	7114-9120	20
N/A	7114-9122	22
N/A	7114-9124	24

2.0mm Cortex Screws, Cruciate Head

Thread Pitch: 0.6mm Core Diameter: 1.3mm Head Diameter: 3.4mm
(7116-2112 Shown)



Cat. No.	Self-Tapping Cat. No.	Length (mm)
7116-2106	7114-9206	6
7116-2108	7114-9208	8
7116-2110	7114-9210	10
7116-2112	7114-9212	12
7116-2114	7114-9214	14
7116-2116	7114-9216	16

2.0mm Cortex Screws, Cruciate Head

Thread Pitch: 0.6mm Core Diameter: 1.3mm Head Diameter: 3.4mm
(7116-2112 Shown)

Cat. No.	Self-Tapping Cat. No.	Length (mm)
7116-2118	7114-9218	18
7116-2120	7114-9220	20
7116-2122	7114-9222	22
7116-2124	7114-9224	24
7116-2126	7114-9226	26
7116-2128	7114-9228	28
7116-2130	7114-9230	30
7116-2132	7114-6232	32
7116-2134*	7114-9234	34
7116-2136*	7114-9236	36
7116-2138*	7114-9238	38

* Sterile

2.0mm Cortex Screws, Hexagonal Head

Thread Pitch: 0.6mm Core Diameter: 1.3mm Head Diameter: 4.0mm
(7116-2012 Shown)



Cat. No.	Self-Tapping Cat. No.	Length (mm)
7116-2006	7114-9306	6
7116-2008	7114-9308	8
7116-2010	7114-9310	10
7116-2012	7114-9312	12
7116-2014	7114-9314	14
7116-2016	7114-9316	16
7116-2018	7114-9318	18
7116-2020	7114-9320	20
7116-2022	7114-9322	22
7116-2024	7114-9324	24
7116-2026	7114-9326	26
7116-2028	7114-9328	28
7116-2030	7114-9330	30
7116-2032	7114-9332	32
7116-2034*	7114-9334	34
7116-3036*	7114-9336	36
7116-3038*	7114-9338	38

* Sterile

2.7mm Cortex Screws

Thread Pitch: 1.0mm Core Diameter: 1.9mm Head Diameter: 5.0mm
(7122-0006 Shown)



Cat. No.	Self-Tapping Cat. No.	Length (mm)
7122-0006	7114-9406	6
7122-0008	7114-9408	8
7122-0010	7114-9410	10
7122-0012	7114-9412	12
7122-0014	7114-9414	14
7122-0016	7114-9416	16
7122-0018	7114-9418	18
7122-0020	7114-9420	20
7122-0022	7114-9422	22
7122-0024	7114-9424	24
7122-0026	7114-9426	26
7122-0028	7114-9428	28
7122-0030	7114-9430	30
7122-0032	7114-9432	32
7122-0034	7114-9434	34
7122-0036	7114-9436	36
7122-0038	7114-9438	38
7122-0040	7114-9440	40
7122-0045*	7114-9445	45
7122-0050*	7114-9450	50
7122-0055*	7144-9455	55

* Sterile

3.5mm Cortex Screws

Thread Pitch: 1.25mm Core Diameter: 2.4mm Head Diameter: 6.0mm
(7122-2045 Shown)

Cat. No.	Self-Tapping Cat. No.	Length (mm)
7122-2028	7114-9528	28
7122-2030	7114-9530	30
7122-2032	7114-9532	32
7122-2034	7114-9534	34
7122-2036	7114-9536	36
7122-2038	7114-9538	38
7122-2040	7114-9540	40
7122-2045	7114-9545	45
7122-2050	7114-9550	50
7122-2055	7144-9555+	55
7122-2060	7144-9560+	60
7122-2065	7114-9565+	65
7122-2070	7114-9570+	70
7122-2075	7114-9575+	75
7122-2080	7114-9580+	80
7122-2085	7114-9585+	85
7122-2090	7114-9590+	90
7122-2095	7114-9595+	95
7122-2100	7114-9600+	100
7122-2105	7114-9605+	105
7122-2110	7114-9610+	110
7122-2115	7114-9515+	115
7122-2120	7114-9520+	120
7122-2125*	7114-9525+	125
7122-2130*	7114-9630+	130

* Sterile + Deep Hex Head

3.5mm Cortex Screws

Thread Pitch: 1.25mm Core Diameter: 2.4mm Head Diameter: 6.0mm
(7122-2045 Shown)



Cat. No.	Self-Tapping Cat. No.	Length (mm)
7122-2010	7114-9510	10
7122-2012	7114-9512	12
7122-2014	7114-9514	14
7122-2016	7114-9516	16
7122-2018	7114-9518	18
7122-2020	7114-9520	20
7122-2022	7114-9522	22
7122-2024	7114-9524	24
7122-2026	7114-9526	26

4.5mm Cortex Screws

Thread Pitch: 1.75mm Core Diameter: 3.0mm Head Diameter: 8.0mm
(7122-5044 Shown)



Cat. No.	Self-Tapping Cat. No.	Length (mm)
7122-5014	7114-9714	14
7122-5016	7114-9716	16
7122-5018	7114-9718	18
7122-5020	7114-9720	20
7122-5022	7114-9722	22
7122-5024	7114-9724	24
7122-5026	7114-9726	26
7122-5028	7114-9728	28
7122-5030	7114-9730	30
7122-5032	7114-9732	32

Trauma Surgery

Internal Fixation

4.5mm Cortex Screws

Thread Pitch: 1.75mm Core Diameter: 3.0mm Head Diameter: 8.0mm
(7122-5044 Shown)

Cat. No.	Self-Tapping Cat. No.	Length (mm)
7122-5034	7114-9734	34
7122-5036	7114-9736	36
7122-5038	7114-9738	38
7122-5040	7114-9740	40
7122-5042	7114-9742	42
7122-5044	7144-9744	44
7122-5046	7114-9746	46
7122-5048	7114-9748	48
7122-5050	7114-9750	50
7122-5052	7114-9752	52
7122-5054	7114-9754	54
7122-5056	7114-9756	56
7122-5058	7114-9758	58
7122-5060	7114-9760	60
7122-5062	7114-9762	62
7122-5064	7114-9764	64
7122-5068	7114-9768	68
7122-5070	7114-9770	70
7122-5072	7114-9772	72
7122-5076	7114-9776	76
7122-5080	7114-9780	80
7122-5085	7114-9785	85
7122-5090	7114-9790	90
7122-5095	7114-9795	95
7122-5100	7114-9800	100
7122-5105	7114-9805	105
7122-5110	7114-9810	110
7122-5115	7114-9815	115
7122-5120	7114-9820	120
7122-5125	7114-9825	125
7122-5130	7114-9830	130
7122-5135	7114-9835	135
7122-5140	7114-9840	140
7122-5145	7114-9845	145

TC-100 Plating and Screws

Systems/Screws/Screw Accessories (Washers & Nuts)

Nut for 4.5mm Cortex Screws

Sterile



Cat. No.

7114-3045

Schanz Screw



Cat. No.	Description	Diameter (mm)	Length (mm)
7117-0315	Diamond Point	6.0	190

Washers

6 per Package



Cat. No.	I.D. (mm)	O.D. (mm)	Packaged
7114-3104	2.2	4.5	Nonsterile
7114-3107	3.7	7.0	Nonsterile
7114-3110	4.7	10.0	Nonsterile
7114-3113	6.6	13.0	Nonsterile
7114-3004	2.2	4.5	Sterile
7114-3007	3.7	7.0	Sterile
7114-3010	4.7	10.0	Sterile
7114-3013	6.6	13.0	Sterile

Wrench for Nut

Cat. No.
7117-0142



TC-100 Plating and Screws Systems/Screws/Specialty Bone Screws

3.5mm Shaft Screws, Sterile, Self-Tapping

Thread Pitch: 1.25mm Core Diameter: 2.4mm Shaft Diameter: 3.5mm
Head Diameter: 6.0mm (7122-5722 Shown)



Cat. No.	Length (mm)	Thread Length (mm)
7122-5716	16	6
7122-5718	18	6
7122-5720	20	6
7122-5722	22	6
7122-5724	24	10
7122-5726	26	10
7122-5728	28	10
7122-5730	30	10
7122-5732	32	12
7122-5734	34	12
7122-5736	36	12
7122-5738	38	12
7122-5710	10	12
7122-5745	45	15
7122-5750	50	15

4.5mm Malleolar Screws

Thread Pitch: 1.75mm Core Diameter: 3.0mm Shaft Diameter: 3.0mm
Head Diameter: 8.0mm (7122-5230 Shown)



Cat. No.	Length (mm)	Thread Length (mm)
7122-5225	25	12
7122-5230	30	15
7122-5235	35	18
7122-5240	40	20
7122-5245	45	22

4.5mm Malleolar Screws

Thread Pitch: 1.75mm Core Diameter: 3.0mm Shaft Diameter: 3.0mm
Head Diameter: 8.0mm (7122-5230 Shown)

Cat. No.	Length (mm)	Thread Length (mm)
7122-5250	50	24
7122-5255	55	26
7122-5260	60	28
7122-5265	65	30
7122-5270	70	32

4.5mm Shaft Screws, Sterile, Self-Tapping

Thread Pitch: 1.75mm Core Diameter: 3.0mm Shaft Diameter: 4.5mm
Head Diameter: 8.0mm (7122-5824 Shown)



Cat. No.	Length (mm)	Thread Length (mm)
7122-5822	22	12
7122-5824	24	12
7122-5826	26	12
7122-5828	28	12
7122-5830	30	12
7122-5832	32	12
7122-5834	34	12
7122-5836	36	12
7122-5838	38	12
7122-5840	40	12
7122-5842	42	12
7122-5844	44	12
7122-5846	46	12
7122-5848	48	12
7122-5850	50	12
7122-5852	52	15
7122-5854	54	15
7122-5856	56	15
7122-5858	58	15
7122-5860	60	15
7122-5864	64	18
7122-5868	68	18
7122-5872	72	18
7122-5876	76	18
7122-5880	80	18
7122-5885	85	22
7122-5890	90	22
7122-5895	95	26
7122-5900	100	26

Trauma Surgery

Internal Fixation

TC-100 Plating and Screws Systems/Sets/Blade Plate Sets

Implant Set, 7116-6193

(Not shown)

Cat. No.	Desc	Shaft Length (mm)	Blade Length (mm)
7122-5400	95→ Adult Condylar Plates, 5 hole	92	50
7122-5401	95→ Adult Condylar Plates, 5 hole	92	60
7122-5402	95→ Adult Condylar Plates, 5 hole	92	70
7122-5403	95→ Adult Condylar Plates, 5 hole	92	80
7122-5404	95→ Adult Condylar Plates, 7 hole	124	50
7122-5405	95→ Adult Condylar Plates, 7 hole	124	60
7122-5406	95→ Adult Condylar Plates, 7 hole	124	70
7122-5407	95→ Adult Condylar Plates, 7 hole	124	80
7122-5408	95→ Adult Condylar Plates, 9 hole	156	50
7122-5409	95→ Adult Condylar Plates, 9 hole	156	60
7122-5410	95→ Adult Condylar Plates, 9 hole	156	70
7122-5411	95→ Adult Condylar Plates, 9 hole	156	80
7122-5412	95→ Adult Condylar Plates, 12 hole	204	50
7122-5413	95→ Adult Condylar Plates, 12 hole	204	60
7122-5414	95→ Adult Condylar Plates, 12 hole	204	70
7122-5415	95→ Adult Condylar Plates, 12 hole	204	80
7112-9401	Small Outer Case		
7112-9402	Lid for Outer Case		
7117-5106	Blade Implant Tray		

Instrument Set, 7116-6191

(Not shown)

Cat. No.	Desc	Qty
7116-1020	2.0 K-wires, 150mm	6
7117-0005	2.0 Drill Bit, 100mm/75mm, QC	2
7117-5013	Triple Drill Guide, 130→	1
7117-5015	Router, QC	1
7117-5100	Chisel Guide, Adjustable Angle	1
7117-5114	Seating Chisel, Adolescent, Child and Small Statured	1
7117-5126	Seating Chisel, Infant	1

Instrument Set, 7116-6191

Cat. No.	Desc	Qty
7117-5132	Seating Chisel, Adult	1
7117-5200	Insertor-Extractor, Adult and Small Statured	1
7117-5210	Insertor-Extractor, Adolescent and Child	1
7117-5300	Slotted Hammer	1
7117-5350	Impactor	1
7117-5400	Tri-Positioning Plate 90/50/40	1
7117-5410	Tri-Positioning Plate 80/70/30	1
7117-5420	Tri-Positioning Plate 100/60/20	1
7117-5450	Quad Positioning Plate 110/90/90/70	1
7117-5460	Condylar Plate Guide	1
7117-5545	4.5mm Hip Drill Guide	1
7112-9401	Small Outer Case	1
7112-9402	Lid for Outer Case	1
7117-5105	Blade Plate Instrument Tray	1

TC-100 Plating and Screws Systems/Sets/Large Fragment Sets/Screw Sets

4.5mm Cortical Screws

(Not shown)

Cat. No.	Screw Length (mm)	Qty
7122/7144-**14	14mm	4
7122/7144-**16	16mm	4
7122/7144-**18	18mm	4
7122/7144-**20	20mm	8
7122/7144-**22	22mm	8
7122/7144-**24	24mm	8
7122/7144-**26	26mm	8
7122/7144-**28	28mm	8
7122/7144-**30	30mm	12
7122/7144-**32	32mm	12
7122/7144-**34	34mm	12
7122/7144-**36	36mm	12
7122/7144-**38	38mm	12
7122/7144-**40	40mm	12
7122/7144-**42	42mm	8
7122/7144-**44	44mm	4
7122/7144-**46	46mm	4
7122/7144-**48	48mm	4
7122/7144-**50	50mm	4
7122/7144-**52	52mm	4
7122/7144-**54	54mm	4

4.5mm Cortical Screws

Cat. No.	Screw Length (mm)	Qty
7122/7144-**56	56mm	4
7122/7144-**58	58mm	4
7122/7144-**60	60mm	4
7122/7144-**62	62mm	4
7122/7144-**64	64mm	4
7122/7144-**66	66mm	4
7122/7144-**68	68mm	4
7122/7144-**70	70mm	4

* The Large Fragment Screw sets are available with self-tapping and non-self-tapping cortical screws. Please use the following key for ease of ordering: SELF-TAPPING Set--7116-6155;7114 prefix ** = 97 NON-SELF-TAPPING Set--7116-6153; 7122 prefix ** = 50

6.5mm Cancellous Screws

Cat. No.	Screw Length (mm)	Thread Length (mm)	Qty
7122-6080	80	16	4
7122-6085	85	16	4
7122-6090	90	16	4
7122-6095	95	16	4
7122-6100	100	16	4
7122-6105	105	16	4
7122-6110	110	16	4
7122-8045	45	32	4
7122-8050	50	32	4
7122-8055	55	32	4
7122-8060	60	32	4
7122-8065	65	32	4
7122-8070	70	32	4
7122-8075	75	32	4
7122-8080	80	32	4
7122-8085	85	32	4
7122-8090	90	32	4
7122-8095	95	32	4
7122-8100	100	32	4
7122-8105	105	32	4
7122-8110	110	32	4
7122-9025	25	fully	4
7122-9030	30	fully	4
7122-9035	35	fully	4
7122-9040	40	fully	4
7122-9045	45	fully	2
7122-9050	50	fully	2
7122-9055	55	fully	2
7122-9060	60	fully	2

4.5mm Malleolar Screws, Sterile (Not shown)

Cat. No.	Screw Length (mm)	Thread Length (mm)	Qty
7122-5225	25	12	2
7122-5230	30	15	2
7122-5235	35	18	2
7122-5240	40	20	2
7122-5245	45	22	2
7122-5250	50	24	2
7122-5255	55	26	2
7122-5260	60	28	2
7122-5265	65	30	2
7122-5270	70	32	2

6.5mm Cancellous Screws (Not shown)

Cat. No.	Screw Length (mm)	Thread Length (mm)	Qty
7122-6030	30	16	4
7122-6035	35	16	4
7122-6040	40	16	4
7122-6045	45	16	4
7122-6050	50	16	4
7122-6055	55	16	4
7122-6060	60	16	4
7122-6065	65	16	4
7122-6070	70	16	4
7122-6075	75	16	4

Instrumentation (Not shown)

Cat. No.	Desc	Qty
7114-3113	Washer, 13mm	6
7117-0045	Screw Forceps	1

Sterilization Trays (Not shown)

Cat. No.	Desc
7117-3103	Large Screw Tray
7117-9401	Small Outer Case
7117-9402	Lid for Outer Case

TC-100 Plating and Screws Systems/Sets/Mini Fragment Sets/Cortical Screw Sets

Cruciate Self-Tapping, 7116-6111 (Not shown)

Cat. No.	Desc	Length (mm)
7114-9006	1.5mm, 6 each	6
7114-9007	1.5mm, 6 each	7
7114-9008	1.5mm, 6 each	8
7114-9009	1.5mm, 6 each	9
7114-9010	1.5mm, 6 each	10
7114-9011	1.5mm, 6 each	11
7114-9012	1.5mm, 6 each	12
7114-9014	1.5mm, 6 each	14
7114-9016	1.5mm, 6 each	16
7114-9018	1.5mm, 6 each	18
7114-9020	1.5mm, 6 each	20
7114-9206	2.0mm, 8 each	6
7114-9208	2.0mm, 8 each	8
7114-9210	2.0mm, 8 each	10
7114-9212	2.0mm, 8 each	12
7114-9214	2.0mm, 8 each	14
7114-9216	2.0mm, 8 each	16
7114-9218	2.0mm, 8 each	18
7114-9220	2.0mm, 8 each	20
7114-9222	2.0mm, 8 each	22
7114-9224	2.0mm, 8 each	24
7114-9406	2.7mm, 6 each	6
7114-9408	2.7mm, 6 each	8
7114-9410	2.7mm, 6 each	10
7114-9412	2.7mm, 6 each	12
7114-9414	2.7mm, 6 each	14
7114-9416	2.7mm, 6 each	16
7114-9418	2.7mm, 6 each	18
7114-9420	2.7mm, 6 each	20
7114-9422	2.7mm, 6 each	22
7114-9424	2.7mm, 6 each	24
7114-3107	Washers, 6 each	7.0
7117-1104	Mini Screw Caddy, 1 each	
7117-0002	Screw Forceps, 1 each	
7117-0037	Cruciform Screwdriver Shaft, 1 each	

Cruciate, 7116-6109

(Not shown)

Cat. No.	Desc	Length (mm)
7116-1606	1.5mm, 6 each	6
7116-1607	1.5mm, 6 each	7
7116-1608	1.5mm, 6 each	8
7116-1609	1.5mm, 6 each	9
7116-1610	1.5mm, 6 each	10
7116-1611	1.5mm, 6 each	11
7116-1612	1.5mm, 6 each	12
7116-1614	1.5mm, 6 each	14
7116-1616	1.5mm, 6 each	16
7116-1618	1.5mm, 6 each	18
7116-1620	1.5mm, 6 each	20
7116-2106	2.0mm, 8 each	6
7116-2108	2.0mm, 8 each	8
7116-2110	2.0mm, 8 each	10
7116-2112	2.0mm, 8 each	12
7116-2114	2.0mm, 8 each	14
7116-2116	2.0mm, 8 each	16
7116-2118	2.0mm, 8 each	18
7116-2120	2.0mm, 8 each	20
7116-2122	2.0mm, 8 each	22
7116-2124	2.0mm, 8 each	24
7122-0006	2.7mm, 6 each	6
7122-0008	2.7mm, 6 each	8
7122-0010	2.7mm, 6 each	10
7122-0012	2.7mm, 6 each	12
7122-0014	2.7mm, 6 each	14
7122-0016	2.7mm, 6 each	16
7122-0018	2.7mm, 6 each	18
7122-0020	2.7mm, 6 each	20
7122-0022	2.7mm, 6 each	22
7122-0024	2.7mm, 6 each	24
7114-3107	Washers, 6 each	7.0
7117-1104	Mini Screw Caddy, 1 each	
7117-0002	Screw Forceps, 1 each	
7117-0037	Cruciform Screwdriver Shaft, 1 each	

Hex Self-Tapping, 7116-6107

(Not shown)

Cat. No.	Desc	Length (mm)
7114-9106	1.5mm, 6 each	6
7114-9107	1.5mm, 6 each	7
7114-9108	1.5mm, 6 each	8
7114-9109	1.5mm, 6 each	9
7114-9110	1.5mm, 6 each	10

Hex Self-Tapping, 7116-6107

Cat. No.	Desc	Length (mm)
7114-9111	1.5mm, 6 each	11
7114-9112	1.5mm, 6 each	12
7114-9114	1.5mm, 6 each	14
7114-9116	1.5mm, 6 each	16
7114-9118	1.5mm, 6 each	18
7114-9120	1.5mm, 6 each	20
7114-9306	2.0mm, 8 each	6
7114-9308	2.0mm, 8 each	8
7114-9310	2.0mm, 8 each	10
7114-9312	2.0mm, 8 each	12
7114-9314	2.0mm, 8 each	14
7114-9316	2.0mm, 8 each	16
7114-9318	2.0mm, 8 each	18
7114-9320	2.0mm, 8 each	20
7114-9322	2.0mm, 8 each	22
7114-9324	2.0mm, 8 each	24
7114-9406	2.7mm, 6 each	6
7114-9408	2.7mm, 6 each	8
7114-9410	2.7mm, 6 each	10
7114-9412	2.7mm, 6 each	12
7114-9414	2.7mm, 6 each	14
7114-9416	2.7mm, 6 each	16
7114-9418	2.7mm, 6 each	18
7114-9420	2.7mm, 6 each	20
7114-9422	2.7mm, 6 each	22
7114-9424	2.7mm, 6 each	24
7114-3107	Washers, 6 each	7.0
7117-1104	Mini Screw Caddy, 1 each	
7117-0002	Screw Forceps, 1 each	

Hex, 7116-6105

(Not shown)

Cat. No.	Desc	Length (mm)
7116-1506	1.5mm, 6 each	6
7116-1507	1.5mm, 6 each	7
7116-1508	1.5mm, 6 each	8
7116-1509	1.5mm, 6 each	9
7116-1510	1.5mm, 6 each	10
7116-1511	1.5mm, 6 each	11
7116-1512	1.5mm, 6 each	12
7116-1514	1.5mm, 6 each	14
7116-1516	1.5mm, 6 each	16
7116-1518	1.5mm, 6 each	18
7116-1520	1.5mm, 6 each	20

Hex, 7116-6105

Cat. No.	Desc	Length (mm)
7116-2206	2.0mm, 8 each	6
7116-2208	2.0mm, 8 each	8
7116-2210	2.0mm, 8 each	10
7116-2212	2.0mm, 8 each	12
7116-2214	2.0mm, 8 each	14
7116-2216	2.0mm, 8 each	16
7116-2218	2.0mm, 8 each	18
7116-2220	2.0mm, 8 each	20
7116-2222	2.0mm, 8 each	22
7116-2224	2.0mm, 8 each	24
7122-0006	2.7mm, 6 each	6
7122-0008	2.7mm, 6 each	8
7122-0010	2.7mm, 6 each	10
7122-0012	2.7mm, 6 each	12
7122-0014	2.7mm, 6 each	14
7122-0016	2.7mm, 6 each	16
7122-0018	2.7mm, 6 each	18
7122-0020	2.7mm, 6 each	20
7122-0022	2.7mm, 6 each	22
7122-0024	2.7mm, 6 each	24
7114-3107	Washers, 6 each	7.0
7117-1104	Mini Screw Caddy, 1 each	
7117-0002	Screw Forceps, 1 each	

TC-100 Plating and Screws Systems/Sets/Pelvic Fragment Sets/Implant Set

3.5 Curved Reconstruction Plates

(Not shown)

Cat. No.	Desc	Qty
7114-0606	6 hole	2
7114-0608	8 hole	2
7114-0610	10 hole	1
7114-0612	12hole	1
7114-0614	14 hole	1
7114-0616	16 hole	1

4.5mm Narrow Compression Plates

(Not shown)

Cat. No.	Desc	Qty
7114-1402	2 hole	2

Trauma Surgery

Internal Fixation

6.5mm Cancellous Screws

(Not shown)

Cat. No.	Screw Length (mm)	Thread Length (mm)	Qty
7122-6115	115	16	3
7122-6120	120	16	3
7122-8115	115	32	3
7122-8120	120	32	3
7122-9045	45	Full Thread	3
7122-9050	50	Full Thread	3
7122-9055	55	Full Thread	3
7122-9060	60	Full Thread	3

Bending Templates

(Not shown)

Cat. No.	Desc	Qty
7117-0177	3.5mm Recon Plates, 22 holes	1
7117-0179	3.5mm Recon Plates, Curved, 22 holes	1
7117-0181	4.5mm Recon Plates, 16 holes	1

Cortical Screws

(Not shown)

Self-Tapping, 7116-6115	Non-Self-Tapping, 7116-6163, Cat. No.	Desc	Screw Length (mm)
7114-9555	7122-2055	3.5mm, 3 each	55
7114-9560	7122-2060	3.5mm, 3 each	60
7114-9565	7122-2065	3.5mm, 3 each	65
7114-9570	7122-2070	3.5mm, 3 each	70
7114-9575	7122-2075	3.5mm, 3 each	75
7114-9580	7122-2080	3.5mm, 3 each	80
7114-9585	7122-2085	3.5mm, 3 each	85
7114-9590	7122-2090	3.5mm, 3 each	90
7114-9595	7122-2095	3.5mm, 3 each	95
7114-9600	7122-2100	3.5mm, 3 each	100
7114-9605	7122-2105	3.5mm, 3 each	105
7114-9610	7122-2110	3.5mm, 3 each	110
7114-9772	7112-5072	4.5mm, 3 each	72
7114-9776	7112-5076	4.5mm, 3 each	76
7114-9780	7112-5080	4.5mm, 3 each	80
7114-9785	7112-5085	4.5mm, 3 each	85
7114-9790	7112-5090	4.5mm, 3 each	90
7114-9795	7112-5095	4.5mm, 3 each	95
7114-9800	7112-5100	4.5mm, 3 each	100
7114-9805	7112-5105	4.5mm, 3 each	105
7114-9810	7112-5110	4.5mm, 3 each	110

Instruments

(Not shown)

Cat. No.	Desc	Qty
7117-0045	Screw Forceps	1

Reconstruction Plates

(Not shown)

Cat. No.	Desc	Qty
7114-0105	3.5mm, 5 hole	2
7114-0106	3.5mm, 6 hole	2
7114-0107	3.5mm, 7 hole	2
7114-0108	3.5mm, 8 hole	2
7114-0109	3.5mm, 9 hole	2
7114-0110	3.5mm, 10 hole	1
7114-0112	3.5mm, 12 hole	1
7114-0114	3.5mm, 14 hole	1
7114-0116	3.5mm, 16 hole	1
7114-0118	3.5mm, 18 hole	1
7114-0003	4.5mm, 3 hole	2
7114-0004	4.5mm, 4 hole	2
7114-0014	4.5mm, 14 hole	1

Sterilization Trays

(Not shown)

Cat. No.	Desc
7117-4105	Pelvic Implant Tray
7112-9401	Small Outer Case
7112-9402	Lid for Outer Case

TC-100 Plating and Screws Systems/Sets/Small Fragment Sets

CP/PF Plate Set, 7116-6127

(Not shown)

Cat. No.	Desc	Qty
7184-0203	3.5mm CP Compression Plates, 3 Hole	1
7184-0204	3.5mm CP Compression Plates, 4 Hole	1
7184-0205	3.5mm CP Compression Plates, 5 Hole	1
7184-0206	3.5mm CP Compression Plates, 6 Hole	2
7184-0207	3.5mm CP Compression Plates, 7 Hole	2
7184-0208	3.5mm CP Compression Plates, 8 Hole	2

CP/PF Plate Set, 7116-6127

Cat. No.	Desc	Qty
7184-0209	3.5mm CP Compression Plates, 9 Hole	1
7184-0210	3.5mm CP Compression Plates, 10 Hole	1
7114-0106	3.5mm Reconstruction Plates, 6 Hole	1
7114-0108	3.5mm Reconstruction Plates, 8 Hole	1
7114-0302	One-Third Tubular Plates with Collar, 2 Hole	1
7113-0303	PF One-Third Tubular Plates with Collar, 3 Hole	1
7113-0304	PF One-Third Tubular Plates with Collar, 4 Hole	2
7113-0305	PF One-Third Tubular Plates with Collar, 5 Hole	2
7113-0306	PF One-Third Tubular Plates with Collar, 6 Hole	2
7113-0307	PF One-Third Tubular Plates with Collar, 7 Hole	2
7113-0308	PF One-Third Tubular Plates with Collar, 8 Hole	1
7113-0310	PF One-Third Tubular Plates with Collar, 10 Hole	1
7113-0403	PF T-Plates, 3 Hole	1
7113-0404	PF T-Plates, 4 Hole	1
7113-0405	PF T-Plates, 5 Hole	1
7113-0503	PF T-Plates, 3 Hole, Oblique	1
7113-0504	PF T-Plates, 4 Hole, Oblique	1
7113-0505	PF T-Plates, 5 Hole, Oblique	1
7113-0603	PF Cloverleaf Plates, 3 Hole	1
7113-0604	PF Cloverleaf Plates, 4 Hole	1
7117-0178	Plate Bending Templates, 8 Hole, Recon	1
7117-1005	Plate Bending Templates, 5 Hole, CP	1
7117-1007	Plate Bending Templates, 7 Hole, CP	1
7117-1009	Plate Bending Templates, 9 Hole, CP	1
7117-2030	Small CP/PF Plate Caddy	1
7117-0088	3.5mm CP Drill Guide, Neutral and Load	1
7117-0012	Quick Connect Adaptor, Mini PF	1
7113-1510	PF Pins, 61mm x 10mm (short thread)	6
7113-1511	PF Pins, 38mm x 13mm (medium thread)	6
7113-1512	PF Pins, 61mm x 23mm (long thread)	6

Instrument Set

(Not shown)

Cat. No.	Desc	Basic, 7116-6121, Qty	Deluxe, 7116-6122, Qty
7116-1012	1.25mm K-wire	6	6
7116-1016	1.6mm K-wire	6	6
7116-1020	2.0mm K-wire	6	6
7117-0015	Small Quick Coupling Handle	1	1
7117-0029	Small Hex Screwdriver	1	1
7117-0031	Holding Sleeve, Small Hex	1	1
7117-0040	Depth Gauge, 60mm	1	1
7117-0043	Sharp Hook	1	1
7117-0045	Screw Forceps	1	
7117-0049	Reduction Forceps, Narrow		1
7117-0051	Reduction Forceps, Broad		1
7117-0052	Reduction Forceps w/ Points	1	
7117-0057	Hohmann Retractor, 8mm	2	2
7117-0063	Wire Bending Pliers		1
7117-0071	2.5mm Drill Bit	3	3
7117-0072	Quick-Connect Adaptor	1	1
7117-0073	3.5mm Drill Bit	2	2
7117-0075	Countersink 2.7/3.5/4.0mm Screws	1	1
7117-0077	3.5mm Tap	2	2
7117-0079	4.0mm Tap	2	2
7117-0083	2.0mm Parallel Drill Guide Sleeve	1	1
7117-0085	2.5mm/3.5mm Double Drill Sleeve	1	1
7117-0086	3.5mm Drill Guide, Neutral and Load	1	1
7117-0087	Universal Drill Guide, 3.5mm		1
7117-0089	2.5mm/3.5mm Insert Drill Sleeve	1	1
7117-0091	Verbrugge Forceps	1	1
7117-0093	Reduction Forceps w/ Serrated Jaws	1	1
7117-0095	Hohmann Retractor, 15mm	2	2
7117-0098	Periosteal Elevator, 6mm Straight	1	1
7117-0099	Bending Iron for K-wires		1
7117-0101	Bending Iron, 2.7mm/3.5mm Plates, L	1	1
7117-0103	Bending Iron, 2.7mm/3.5mm Plates, R	1	1
7117-0117	Small T-Handle	1	1

Instrument Set

Cat. No.	Desc	Basic, 7116-6121, Qty	Deluxe, 7116-6122, Qty
7117-0167	Holding Sleeve, Small Hex	1	1
7117-0173	Bending Iron, Recon Plates		1
7117-1035	Hex Screwdriver Shaft, Small	1	1
7117-2023	Small Drill Caddy	1	1
7117-2024	Small Instrument Caddy, Basic	1	
7117-2025	Small Instrument Caddy, Deluxe		1
7112-9401	Small Outer Case	1	1
7112-9402	Lid for Outer Case	1	1

PF Plate Set, 7116-6125

(Not shown)

Cat. No.	Desc	Qty
7114-0203	3.5mm Compression Plates, 3 Hole	1
7113-0204	3.5mm Compression Plates, 4 Hole	2
7113-0205	3.5mm PF Compression Plates, 5 Hole	1
7113-0206	3.5mm PF Compression Plates, 6 Hole	2
7113-0207	3.5mm PF Compression Plates, 7 Hole	2
7113-0208	3.5mm PF Compression Plates, 8 Hole	2
7113-0209	3.5mm PF Compression Plates, 9 Hole	1
7113-0210	3.5mm PF Compression Plates, 10 Hole	1
7114-0106	3.5mm Reconstruction Plates, 6 Hole	1
7114-0108	3.5mm Reconstruction Plates, 8 Hole	1
7114-0302	One-Third Tubular Plates with Collar, 2 Hole	1
7113-0303	PF One-Third Tubular Plates with Collar, 3 Hole	1
7113-0304	PF One-Third Tubular Plates with Collar, 4 Hole	1
7113-0305	PF One-Third Tubular Plates with Collar, 5 Hole	2
7113-0306	PF One-Third Tubular Plates with Collar, 6 Hole	2
7113-0307	PF One-Third Tubular Plates with Collar, 7 Hole	2
7113-0308	PF One-Third Tubular Plates with Collar, 8 Hole	1
7113-0310	PF One-Third Tubular Plates	1

PF Plate Set, 7116-6125

Cat. No.	Desc	Qty
	with Collar, 10 Hole	
7113-0404	PF T-Plates, 4 Hole	1
7113-0405	PF T-Plates, 5 Hole	1
7113-0503	PF T-Plates, 3 Hole, Oblique	1
7113-0504	PF T-Plates, 4 Hole, Oblique	1
7113-0505	PF T-Plates, 5 Hole, Oblique	1
7113-0603	PF Cloverleaf Plates, 3 Hole	1
7113-0604	PF Cloverleaf Plates, 4 Hole	1
7117-0178	Plate Bending Templates, 8 Hole, Recon	1
7117-1005	Plate Bending Templates, 5 Hole	1
7117-1007	Plate Bending Templates, 7 Hole	1
7117-1009	Plate Bending Templates, 9 Hole	1
7117-0012	Quick Connect Adaptor, Mini PF	1
7117-2032	Small PF Plate Caddy	1
7113-1510	PF Pins, 61mm x 10mm (short thread)	6
7113-1511	PF Pins, 38mm x 13mm (medium thread)	6
7113-1512	PF Pins, 61mm x 23mm (long thread)	6

Screw Sets

(Not shown)

Cat. No.	Desc	Basic Set*, 7116-6129, Qty	Deluxe Set*, 7116-6131, Qty
7122/7144-**10	3.5mm Cortical Screws, 10mm	8	8
7122/7144-**12	3.5mm Cortical Screws, 12mm	8	8
7122/7144-**14	3.5mm Cortical Screws, 14mm	8	8
7122/7144-**16	3.5mm Cortical Screws, 16mm	8	8
7122/7144-**18	3.5mm Cortical Screws, 18mm	8	8
7122/7144-**20	3.5mm Cortical Screws, 20mm	8	8
7122/7144-**22	3.5mm Cortical Screws, 22mm	8	8
7122/7144-**24	3.5mm Cortical Screws, 24mm	8	8
7122/7144-**26	3.5mm Cortical Screws, 26mm	8	8
7122/7144-**28	3.5mm Cortical Screws, 28mm	8	8
7122/7144-**30	3.5mm Cortical Screws, 30mm		8
7122/7144-**32	3.5mm Cortical	8	8

Screw Sets

Cat. No.	Desc	Basic Set*, 7116-6129, Qty	Deluxe Set*, 7116-6131, Qty
	Screws, 32mm		
7122/7144-**34	3.5mm Cortical Screws, 34mm		6
7122/7144-**36	3.5mm Cortical Screws, 36mm	8	6
7122/7144-**38	3.5mm Cortical Screws, 38mm		6
7122/7144-**40	3.5mm Cortical Screws, 40mm	8	6
7122/7144-**45	3.5mm Cortical Screws, 45mm	6	6
7122/7144-**50	3.5mm Cortical Screws, 50mm	6	6
7112-3010	4.0mm Fully Threaded Cancellous Screws, 10mm		6
7112-3012	4.0mm Fully Threaded Cancellous Screws, 12mm		6
7112-3014	4.0mm Fully Threaded Cancellous Screws, 14mm	6	6
7112-3016	4.0mm Fully Threaded Cancellous Screws, 16mm	6	6
7112-3018	4.0mm Fully Threaded Cancellous Screws, 18mm	6	6
7112-3020	4.0mm Fully Threaded Cancellous Screws, 20mm	6	6
7112-3022	4.0mm Fully Threaded Cancellous Screws, 22mm	6	6
7112-3024	4.0mm Fully Threaded Cancellous Screws, 24mm	6	6
7112-3026	4.0mm Fully Threaded Cancellous Screws, 26mm	6	6
7112-3028	4.0mm Fully Threaded Cancellous Screws, 28mm	6	6
7112-3030	4.0mm Fully Threaded Cancellous Screws, 30mm		6
7112-3032	4.0mm Fully Threaded Cancellous Screws, 32mm	6	
7112-3035	4.0mm Fully Threaded Cancellous Screws, 35mm		6
7112-3036	4.0mm Fully Threaded Cancellous Screws, 36mm	6	
7112-3040	4.0mm Fully Threaded Cancellous Screws, 40mm	6	6
7112-3045	4.0mm Fully Threaded	6	6

Screw Sets

Cat. No.	Desc	Basic Set*, 7116-6129, Qty	Deluxe Set*, 7116-6131, Qty
	Cancellous Screws, 45mm		
7112-3050	4.0mm Fully Threaded Cancellous Screws, 50mm	6	6
7112-3055	4.0mm Fully Threaded Cancellous Screws, 55mm	4	4
7112-3060	4.0mm Fully Threaded Cancellous Screws, 60mm	4	4
7112-3210	4.0mm Partially Threaded Cancellous Screws, 10mm		6
7112-3212	4.0mm Partially Threaded Cancellous Screws, 12mm	6	6
7112-3214	4.0mm Partially Threaded Cancellous Screws, 14mm	6	6
7112-3216	4.0mm Partially Threaded Cancellous Screws, 16mm	6	6
7112-3218	4.0mm Partially Threaded Cancellous Screws, 18mm	6	6
7112-3220	4.0mm Partially Threaded Cancellous Screws, 20mm	6	6
7112-3222	4.0mm Partially Threaded Cancellous Screws, 22mm	6	6
7112-3224	4.0mm Partially Threaded Cancellous Screws, 24mm	6	6
7112-3226	4.0mm Partially Threaded Cancellous Screws, 26mm	6	6
7112-3228	4.0mm Partially Threaded Cancellous Screws, 28mm	6	6
7112-3230	4.0mm Partially Threaded Cancellous Screws, 30mm	6	6
7112-3235	4.0mm Partially Threaded Cancellous Screws, 35mm	6	6
7112-3240	4.0mm Partially Threaded Cancellous Screws, 40mm	6	6
7112-3245	4.0mm Partially Threaded Cancellous Screws, 45mm	6	6
7112-3250	4.0mm Partially Threaded Cancellous Screws, 50mm	6	6
7114-3107	Washer, 7.0mm	6	6
7117-0045	Screw Forceps	1	1
7117-2005	Small Fragment Screw	1	

Screw Sets

Cat. No.	Desc	Basic Set*,		Deluxe Set*,	
		7116-6129, Qty		7116-6131, Qty	
	Caddy, Basic				
7117-2020	Small Fragment Screw			1	
	Caddy, Deluxe				

* The Small Fragment Screw sets are available with self-tapping and non-self-tapping cortical screws. Please use the following key for ease of ordering: SELF-TAPPING Basic Set--7116-6129; Deluxe Set--7116-6131;7114 prefix ** = 95 NON-SELF-TAPPING Basic Set--7116-6128; Deluxe Set--7116-6130; 7122 prefix ** = 20

TC-100 Plate Set

Cat. No.	Desc	Basic Set,		Deluxe Set,	
		7116-6123, Qty		7116-6124, Qty	
7114-0405	T-Plates, 5 Hole				1
7114-0503	T-Plates, 3 Hole, Oblique	1			1
7114-0504	T-Plates, 4 Hole, Oblique				1
7114-0505	T-Plates, 5 Hole, Oblique	1			1
7114-0603	Cloverleaf Plates, 3 Hole	1			1
7114-0604	Cloverleaf Plates, 4 Hole	1			1
7117-0178	Plate Bending Templates, 8 Hole, Recon				1
7117-1005	Plate Bending Templates, 5 Hole	1			1
7117-1007	Plate Bending Templates, 7 Hole	1			1
7117-1009	Plate Bending Templates, 9 Hole				1
7117-2021	Small Plate Caddy, Basic			1	
7117-2031	Small Plate Caddy, Deluxe				1

TC-100 Plate Set

(Not shown)

Cat. No.	Desc	Basic Set,		Deluxe Set,	
		7116-6123, Qty		7116-6124, Qty	
7114-0203	3.5mm Compression Plates, 3 Hole				1
7114-0204	3.5mm Compression Plates, 4 Hole				1
7114-0205	3.5mm Compression Plates, 5 Hole				1
7114-0206	3.5mm Compression Plates, 6 Hole	2			2
7114-0207	3.5mm Compression Plates, 7 Hole	2			2
7114-0208	3.5mm Compression Plates, 8 Hole	2			2
7114-0209	3.5mm Compression Plates, 9 Hole				1
7114-0210	3.5mm Compression Plates, 10 Hole	2			1
7114-0106	3.5mm Reconstruction Plates, 6 Hole				1
7114-0108	3.5mm Reconstruction Plates, 8 Hole				1
7114-0302	One-Third Tubular Plates with Collar, 2 Hole	1			1
7114-0303	One-Third Tubular Plates with Collar, 3 Hole	1			1
7114-0304	One-Third Tubular Plates with Collar, 4 Hole	2			1
7114-0305	One-Third Tubular Plates with Collar, 5 Hole	2			2
7114-0306	One-Third Tubular Plates with Collar, 6 Hole	2			2
7114-0307	One-Third Tubular Plates with Collar, 7 Hole	1			2
7114-0308	One-Third Tubular Plates with Collar, 8 Hole	1			1
7114-0310	One-Third Tubular Plates with Collar, 10 Hole				1
7114-0403	T-Plates, 3 Hole			1	
7114-0404	T-Plates, 4 Hole			1	

TC-100 Plating and Screws Systems/Trays/Blade Plate Trays

Blade Plate Implant Tray

Cat. No.
7117-5106



Blade Plate Instrument Tray

Cat. No.
7117-5105



TC-100 Plating and Screws Systems/Trays/Large Fragment Trays

Large Forceps Tray

Cat. No.
7117-3102



Large Plate Tray, PF

Cat. No.
7117-3107



Large Instrument Tray

Cat. No.
7117-3101



Large Screw Tray

Cat. No.
7117-3103



Large Plate Tray

Cat. No.
7117-3105



TC-100 Plating and Screws Systems/Trays/Mini
Fragment Trays

Mini Drill Caddy

Cat. No.
7117-1108

(Not shown)

Large Plate Tray, CP/PF

Cat. No.
7117-2033



Mini Instrument Caddy

Cat. No.
7117-1102

(Not shown)

Mini Plate Caddy

Cat. No.
7117-1103

(Not shown)

Mini Screw Caddy

Cat. No.
7117-1104

(Not shown)

TC-100 Plating and Screws Systems/Trays/Pelvic Fragment Trays

Pelvic Implant Tray

Cat. No.
7117-4105



Pelvic Instrument Tray

Cat. No.
7117-4101

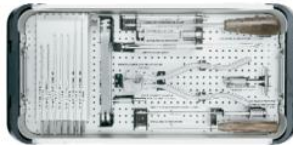

Pelvic Reduction Instrument Tray A

Cat. No.
7117-4103



Pelvic Reduction Instrument Tray B

Cat. No.
7117-4107

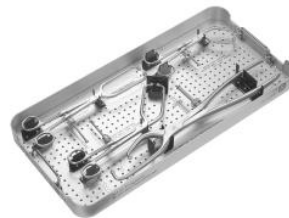

Pelvic Reduction Instrument Tray C

Cat. No.
7117-4109



TC-100 Plating and Screws Systems/Trays/Small Fragment Trays

Small CP/PF Plate Caddy

Cat. No.
7117-2030



Small Drill Caddy

Cat. No.
7117-2023



Small Instrument Caddy, Basic

Cat. No.
7117-2024



Small Instrument Caddy, Deluxe

Cat. No.
7117-2025



Small Screw Caddy Basic

Cat. No.
7117-2005



Small PF Plate Caddy

Cat. No.
7117-2032



Small Screw Caddy Deluxe

Cat. No.
7117-2020



Small Plate Caddy Basic

Cat. No.
7117-2021



Small Plate Caddy Deluxe

Cat. No.
7117-2031

